



# Rigid Core Loc Herringbone Installation Instructions

EN

## GENERAL INFORMATION

Rigid Core Loc Herringbone Design Vinyl Flooring is a PVC construction over a rigid core with a built in underlay to offer a strong, durable construction which is 100% waterproof\* and offers impressive acoustic performance. The plank size is 101.6mm x 609.6mm. The planks are locked together without the need for any adhesive by a unique locking system to create a floating floor where the planks can be installed and locked together in a single action. Rigid Core Loc Herringbone incorporates an acoustic base and therefore requires no additional underlay. To ensure the best finished appearance it is essential to both engage the services of a professional resilient flooring installer for installation expertise. Any warranty offered is conditional on both a professional installation being undertaken; and the close following of these installation instructions.

## PRIOR TO INSTALLATION

When installing Rigid Core Loc Herringbone Vinyl Flooring planks always follow current national standards for the installation of floor coverings. Current installation best practice incorporating the latest technical developments should also be employed. The preparation of the subfloor, the installation of the floor covering and the measures taken to safeguard value are key factors in ensuring optimum suitability and performance of resilient floor coverings. On receipt of materials, check that the colours correspond to those ordered and that there is no damage or visual defects in the material. Check that the material is from one batch; (if that was ordered). Claims for visual defects can only be accepted prior to installation and cutting.

## PREPARATION OF SUBFLOORS

Subfloors should be prepared as described in BS 8203 / DIN 18365 or prevailing local / national standards. Rigid Core Loc Herringbone Vinyl Flooring can be installed over most hard subfloors, provided they are prepared in accordance with local standards. Subfloors must be hard, clean, and free from contamination, dry, durable, flat and sound. Solid subfloors must be tested in accordance to local standards to ensure they are not damp. Carpets and soft floorings are unsuitable as a base for the installation of Rigid Core Loc Herringbone Vinyl Flooring and will need to be removed prior to installation. Remove all debris and vacuum the whole subfloor area prior to commencing the installation. Where underfloor heating is used the maximum temperature on the surface of the flooring must never exceed 27°C. Subfloors should be tested for moisture in accordance with local standards. Solid subfloors should demonstrate a maximum damp content of 75%RH before the installation can begin.

Residual moisture content:

Cement	without UFH	2% CM
	with UFH	1.8% CM
Anhydrite	without UFH	0.5% CM
	with UFH	0.3% CM

Remove any unevenness in the subfloor prior to installation. Subfloor levels should be in accordance with local national standards and in any event, should never exceed a maximum deviation of 5mm when measured under a 3m long straight edge. High spots and ridges should be removed to prevent damaging the plank's locking mechanism.

## CONDITIONING

Rigid Core Loc Herringbone Vinyl Flooring must be protected against dirt and moisture during storage and both before and during the installation. The climatic conditions acceptable for the installation of Rigid Core Loc Herringbone Vinyl Flooring are:

- Floor temperature > 15°C
- Room temperature > 18°C

Prior to installation, open the boxes and place them in the room they are to be installed in for a minimum of 48 hours BEFORE the installation commences, so the material can acclimatise. Boxes should never be stacked greater than 3 high during this time.

Ensure that the room temperatures are between 18 and 27°C during the acclimatisation period. Shuffle the planks to ensure a random appearance before installation.

## INSTALLATION

As Rigid Core Loc Herringbone Vinyl Flooring is a floating floor, a minimum expansion gap of 5mm should be left around the entire installation perimeter and anything protruding from the subfloor such as radiator pipes, pillars, columns – any fixed down items. For larger installations over 5m x 5m an expansion gap of 1mm per linear meter of room length should be used\*\*. For example, a room 8m x 4m would require an expansion gap of 8mm around the entire perimeter of the room and around anything protruding from the floor. In areas of 5m x 5m and under; use small offcuts as spacers between the planks and the walls to help achieve the correct expansion gap size. Skirting boards should be removed and door frames / architraves undercut to allow for possible expansion. A suitable quadrant or scotia trim can be used to cover the expansion gap. In larger areas use specifically sized spacing strips.

Rigid Core Loc Herringbone Vinyl Flooring is a loose lay product. In areas subject to large temperature fluctuations such as heavily glazed areas and areas subject to direct sunlight, special care must be taken including a larger expansion gap of a minimum 10mm and adequate UV protection.

If installing in multiple rooms, finish the Rigid Core Loc Herringbone Vinyl Flooring planks in the doorway on either side of the door to make separate floors. Allow a larger expansion gap between two such floors of double that left around the perimeter. Use two small offcut pieces of Rigid Core Loc Herringbone Vinyl Flooring placed back-to-back to gauge the correct expansion gap size at door thresholds. A suitable threshold strip can then be installed to cover the resultant gap. Rigid Core Loc Herringbone Vinyl Flooring should never be installed across multiple rooms as one floor. When adjoining other floor coverings, finish the Rigid Core Loc Herringbone Vinyl Flooring in the doorway. An appropriate expansion gap should be left between the Rigid Core Loc Herringbone Vinyl Flooring and the adjoining floor covering. This can be covered using a suitable threshold or diminishing strip (see diagram below). Planks must always be laid in a simple herringbone pattern. Areas over 10m x 10m will require specialist advice. Please contact Polyflor's Customer Technical Support Dept on +44 (0)161 767 1912.

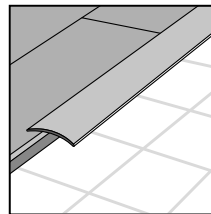

## YOU WILL NEED

- Pencil
- Utility knife
- Retractable measuring tape or folding ruler
- Handsaw / Powered Multi Tool
- Plunge Saw
- Carpenter's adjustable square
- Suitable Straight Edge
- Pull bar
- 0.9mm wire
- Spacers

The use of safety glasses and protective gloves should also be considered.

Further information relating to the installation of this and all Polyflor products can be found in the Technical Section of the Polyflor website [polyflor.com](http://polyflor.com)

\* Rigid Core Loc Herringbone Vinyl Flooring planks are 100% waterproof. Therefore, they will not absorb water and the structural integrity of the product will not be affected by water e.g: no swelling. In the case of standing water or flooding, Rigid Core Loc Herringbone Vinyl Flooring will not act as a barrier between standing water/flooding and the subfloor, and as such is not recommended for continually wet areas such as walk-in shower rooms.

\*\* Room Length is dictated by using the length of the longest wall.



## Important Information

- The key to a successful floating Herringbone installation is to first form a number of triangles from A and B planks as shown below in figures 1.1 – 4.1 which fit along the longest wall to commence the installation.
- As this is a floating installation it is important to calculate the required expansion gap before commencing the installation – (see General Information on Page 1) use spacers between the wall and the perimeter planks to maintain the correct expansion gap.
- No additional underlay is required - see subfloor preparation information (General Information Page 1).
- The flooring must be acclimated for a minimum of 48 hours prior to installation in the room where the installation will take place. Boxes should not be stacked more than three high during the acclimatisation process.
- Areas exceeding 10 linear metres or 100 sqm may require an additional expansion joint; Contact Polyflor Customer Technical Support Dept on +44 (0)161 767 1912 for further advice.
- Never install very heavy pieces of furniture such as kitchen islands/cabinets directly on top of the flooring.
- The climatic conditions for installation should be: a floor temp of >15°C and a room temp of between 18-27°C.
- Always follow the prevailing local and/or national standards surrounding subfloor preparation.
- Your attention is drawn to the General Information on Page 1 for further details relating to installation.
- Full details of the installation methods used for 5G ranges can be found in the Polyflor Technical Information manual ([www.polyflor.com](http://www.polyflor.com)).

## 1. Separate planks into A and B planks

- The box contents are equally split between A and B planks. To form a Herringbone installation it's important that the planks are correctly identified and kept separated during the installation.
- A-planks can be identified by the lower female profile being on the Left hand side; and the B-planks with the lower female profile on the Right hand side (see figure 1.1).

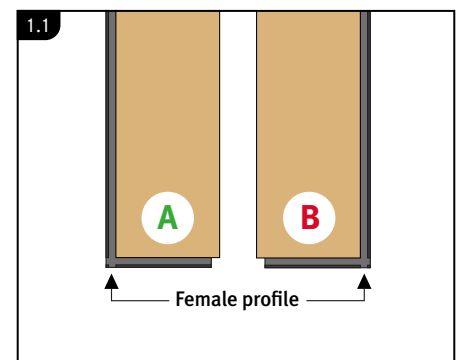

## 2. Build starting triangles

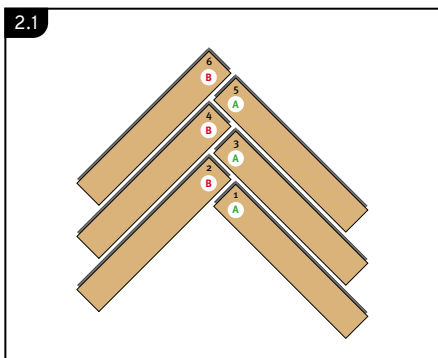

Take A-planks and B-planks and position them as shown in figure 2.1.

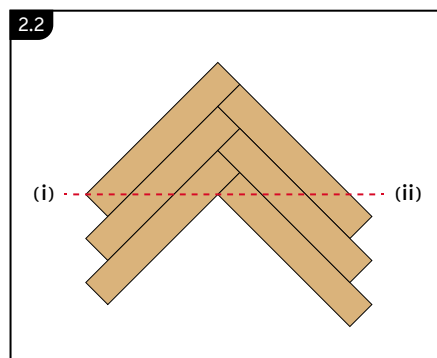

Install the planks precisely and in the order indicated by the numbers on the planks in figure 2.1. Carefully check that each individual plank is correctly aligned and engaged. Mark a line from points (i) to (ii) as illustrated in figure 2.2, ensuring that a 45 degree angle is achieved.

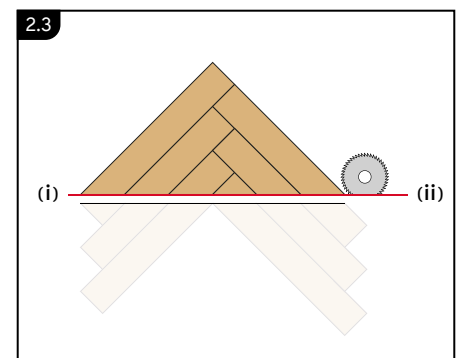

Using a plunge/circular saw set at the correct depth – cut the assembled triangle at the marked line from point (i) to (ii). Alternatively, the marked triangle can be disengaged and cut with a utility knife, prior to reassembling the triangle.

### 3. Calculating the number of triangles

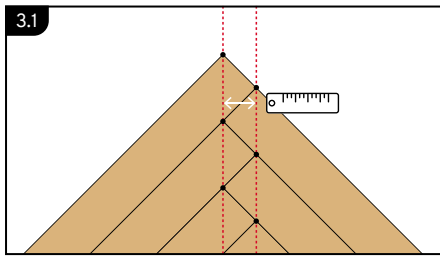

Measure the distance between the two straight lines, originating from the corners of the planks.

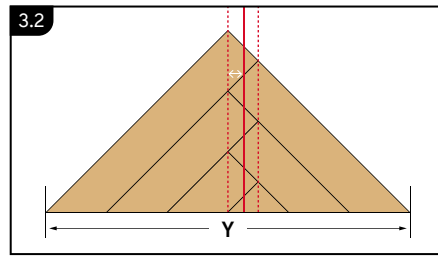

Divide this number by two and get the **X measurement**. The **Y measurement** is the width of the triangle at its widest point as show in figure 3.2.

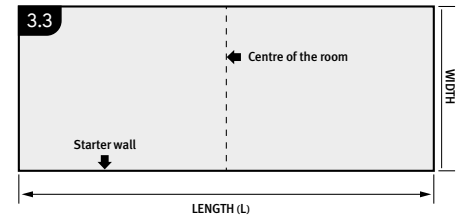

Define the wall from where you intend to start the installation. Mark out the centre of the room. For advice on irregular shaped rooms please contact Polyflor Customer Technical Support Dept on +44 (0)161 767 1912.

**Tip: the longest wall is usually the best wall to start from.**

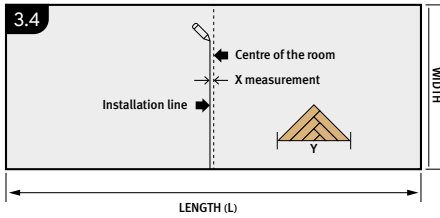

Drawing the installation line. Start from the centre of the room. Parallel offset the line using the **X measurement** as distance.

$$\frac{L + X}{Y} = \text{Quantity}$$

Calculate the number of starting triangles needed with the formula in figure 3.5.

**Tip: Round up to the next full number.**

### 4. Start installation

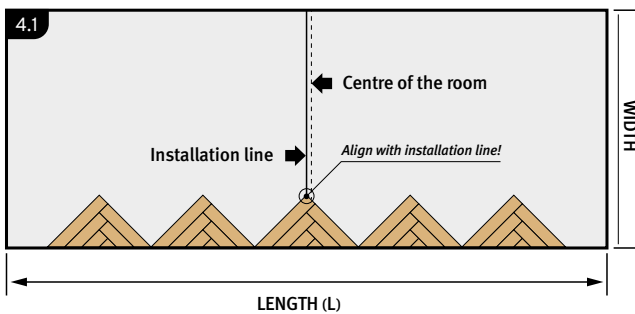

Lay out the triangles with their long side towards the starting wall. Align the tip of centre triangle with the installation line. Position spacers between the wall and the triangle bases.

**Tip: Use small offcuts as spacers for the expansion gap.**

### 5. Finalising the start row

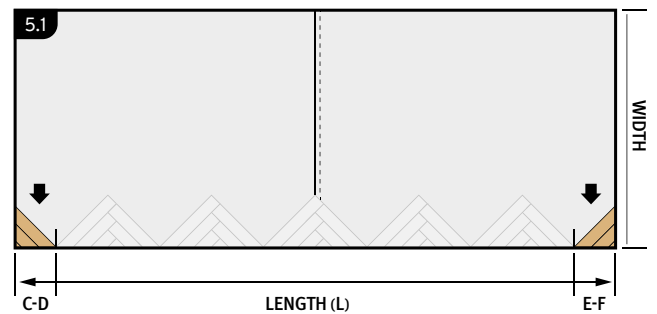

Now cut the distances C-D and E-F from the remaining triangle(s), and position them as shown in figure 5.1.

### 6. Further installation of rows

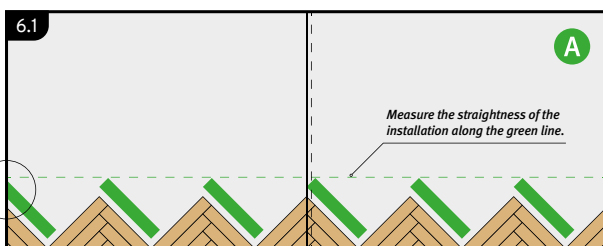

Install A-planks to connect the triangles. The joints need to be checked carefully to ensure the planks are correctly aligned and fully engaged. Cut in the last piece on the left hand side (as indicated) to fit to the perimeter wall, not forgetting the expansion gap.

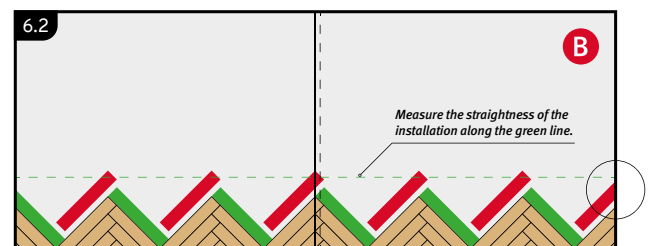

Next install the B-planks. Cut in the last piece on the right hand side (as indicated) to fit to the perimeter wall, not forgetting the expansion gap. Measure the alignment of the tips of the triangles along the horizontal dotted green line above using a suitable length straight edge. Repeat this check throughout the remainder of the installation. Any deviations should be brought back in line.

## 7. Last row installation

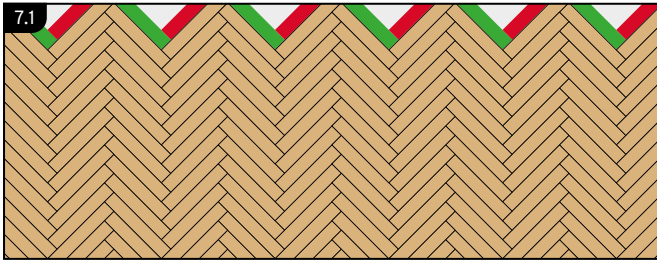

Continue this alternating installation of A and B planks throughout the remainder of the installation. It is important to check frequently that:

- All expansion spacers remain in position.
- All planks are aligned and the joints are fully engaged.
- The installation line is being closely followed.

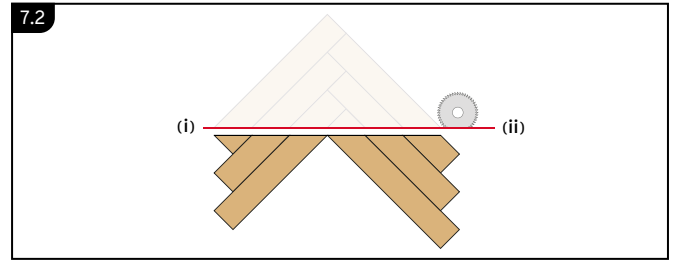

Carefully remove spacers to complete the installation.

**Tip:** to reduce waste the offcuts from starting triangles may be used to complete the final row.

## 8. Final row where angling is not possible

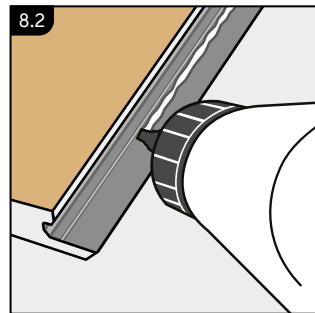
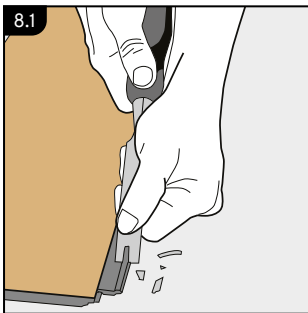

Where the planks can no longer be installed together using the Angled Fold Down Installation method. Remove the upstand on the locking element of the protruding lower female profile (fig. 8.1). Then, use a suitable contact adhesive in accordance with the manufacturer's instruction (fig. 8.2) to connect the planks. Remember to place spacers between these planks and the wall to maintain the expansion gap.

## 9. Installation around radiator/heating pipes

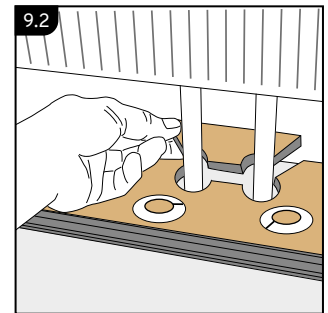
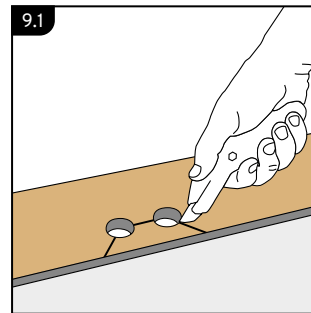

Mark the centres of the holes on both the long and short sides using a carpenter's square and a pencil. Where the marks cross, drill a pilot hole using a thin #6 or #8 drill bit. Further drill the hole with a spade bit wide enough to accommodate both the diameter of the pipe and the required expansion gap. Cut around as shown with a saw or utility knife (fig. 9.1) and put a bead of suitable contact adhesive on the cut piece and replace (fig. 9.2). Insert a spacer directly behind the inserted piece to wedge it in place ensuring that the correct sized expansion gap has been left. Leave this in place until the adhesive has hardened.

## Dismantling of installed planks

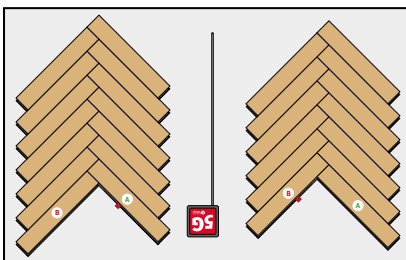

When a plank is correctly locked, it may not be possible to take it up or remove it by hand without damaging the planks. Planks can be dismantled using a 0.9mm wire.

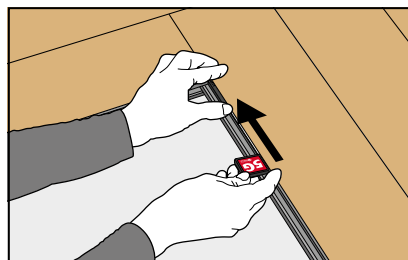

Align the 0.9mm wire with the installed 5G joint so that the wire is between the profile of the last installed plank and the flexible tongue. Push forward the 0.9mm wire into the joint. This pushes back the flexible tongue and releases the plank for dismantling.

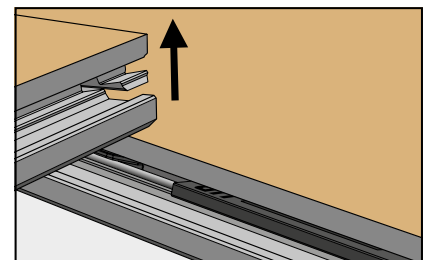

The plank should now lift up easily on the long side.

## GENERAL INFORMATION

Rigid Core Loc Vinyl Flooring is constructed of PVC over a rigid core to offer a strong, durable construction which is 100% waterproof\* and offers impressive acoustic performance. The plank size is 177.35mm x 1212.4mm. The planks are locked together without the need for any glue by a unique locking system to create a floating floor where the planks can be installed and locked together in a single action. Rigid Core Loc Vinyl Flooring incorporates an acoustic base and therefore requires no underlay. To ensure the best finished appearance it is essential to follow these installation instructions carefully.

## PRIOR TO INSTALLATION

When installing Rigid Core Loc Vinyl Flooring planks always follow current national standards for the installation of floor coverings. Best current installation practice incorporating the latest technical developments should also be employed. The preparation of the subfloor, the installation of the floor covering and the measures taken to safeguard value are key factors in ensuring optimum suitability and performance of resilient floor coverings. On receipt of materials, check that the colours correspond to those ordered and that there is no damage or visual defects in the material. Check that the material is from one batch. Claims for visual defects can only be accepted prior to installation and cutting.

## PREPARATION OF SUBFLOORS

Subfloors should be prepared as described in BS 8203 / DIN 18365 or prevailing local / national standards. Rigid Core Loc Vinyl Flooring can be installed over most hard subfloors, provided they are prepared in accordance with local standards. Subfloors must be hard, clean, and free from contamination, dry, durable, flat and sound. Solid subfloors must be tested in accordance to local standards to ensure they are not damp. Carpets and soft floorings are unsuitable as a base for the installation of Rigid Core Loc Vinyl Flooring and will need to be removed prior to installation. Remove all debris and vacuum the whole subfloor area prior to commencing the installation. Where underfloor heating is used the maximum temperature on the surface of the flooring must never exceed 27°C. Subfloors should be tested for moisture in accordance with local standards. Solid subfloors should demonstrate a maximum damp content of 75%RH before the installation can begin.

Residual moisture content:

Cement	without UFH	2% CM
	with UFH	1.8% CM
Anhydrite	without UFH	0.5% CM
	with UFH	0.3% CM

Remove any unevenness in the subfloor prior to installation. Subfloor levels should be in accordance with local national standards and in any event, should never exceed a maximum deviation of 5mm when measured under a 3m long straight edge. High spots and ridges should be removed to prevent damaging the planks locking mechanism.

## CONDITIONING

Rigid Core Loc Vinyl Flooring must be protected against dirt and moisture during storage and both before and during the installation. The climatic conditions acceptable for the installation of Rigid Core Loc Vinyl Flooring are:

- Floor temperature > 15°C
- Room temperature > 18°C

Prior to installation, open the boxes and place them in the room they are to be installed in for a minimum of 48 hours BEFORE the installation commences, so the material can acclimatise. Boxes should never be stacked greater than 3 high.

Ensure that the room temperatures are between 18 and 27°C during the conditioning period. Shuffle the planks to ensure a random appearance before installation.

## INSTALLATION

As Rigid Core Loc Vinyl Flooring is a floating floor, a minimum expansion gap of 5mm should be left around the entire installation perimeter and anything protruding from the subfloor such as radiator pipes, fixed down items etc. For larger installations over 5m x 5m an expansion gap of 1mm per linear meter of room length should be used\*\*. For example, a room 8m x 4m would require an expansion gap of 8mm around the entire perimeter of the room and around anything protruding from the floor. In areas under 5m x 5m use small offcuts as spacers between the planks and the walls to help achieve the correct expansion gap size. Skirting boards should be removed and door frames / architraves undercut to allow for possible expansion. A suitable quadrant or scotia trim can be used to cover the expansion gap.

Rigid Core Loc Vinyl Flooring is a loose lay product. In areas subject to large temperature fluctuations such as heavily glazed areas and areas subject to direct sunlight, special care must be taken including a larger expansion gap of a minimum 10mm and adequate UV protection.

If installing in multiple rooms, finish the Rigid Core Loc Vinyl Flooring planks in the doorway on either side of the door to make separate floors. Allow a larger expansion gap between two such floors of double that left around the perimeter. Use two small offcut pieces of Rigid Core Loc Vinyl Flooring placed back-to-back to gauge the correct expansion gap size at door thresholds. A suitable threshold strip can then be installed to cover the resultant gap. Rigid Core Loc Vinyl Flooring should never be installed across multiple rooms as one floor. Planks should always be laid with staggered joints, at a distance of at least 150mm. When adjoining other floor coverings, finish the Rigid Core Loc Vinyl Flooring in the doorway. An appropriate expansion gap should be left between the Rigid Core Loc Vinyl Flooring and the adjoining floor covering. This can be covered using a suitable threshold or diminishing strip (see diagram below). Areas over 10m x 10m will require specialist advice. Please contact Polyflor's Customer Technical Support Dept on +44 (0)161 767 1912.

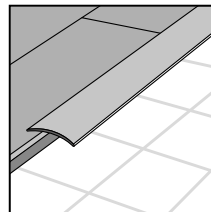

## YOU WILL NEED

- Pencil
- Utility knife
- Retractable measuring tape or folding ruler
- Handsaw / Hacksaw
- Carpenter's 90° square
- Pull bar

The use of safety glasses and protective gloves should also be considered.

\* Rigid Core Loc Vinyl Flooring planks are 100% waterproof. Therefore, they will not absorb water and the structural integrity of the product will not be affected by water e.g: no swelling. In the case of standing water or flooding, Rigid Core Loc Vinyl Flooring will not act as a barrier between standing water/flooding and the subfloor, and as such is not recommended for continually wet areas such as walk-in shower rooms.

\*\* Room Length follows the direction the longest side of the plank is installed.

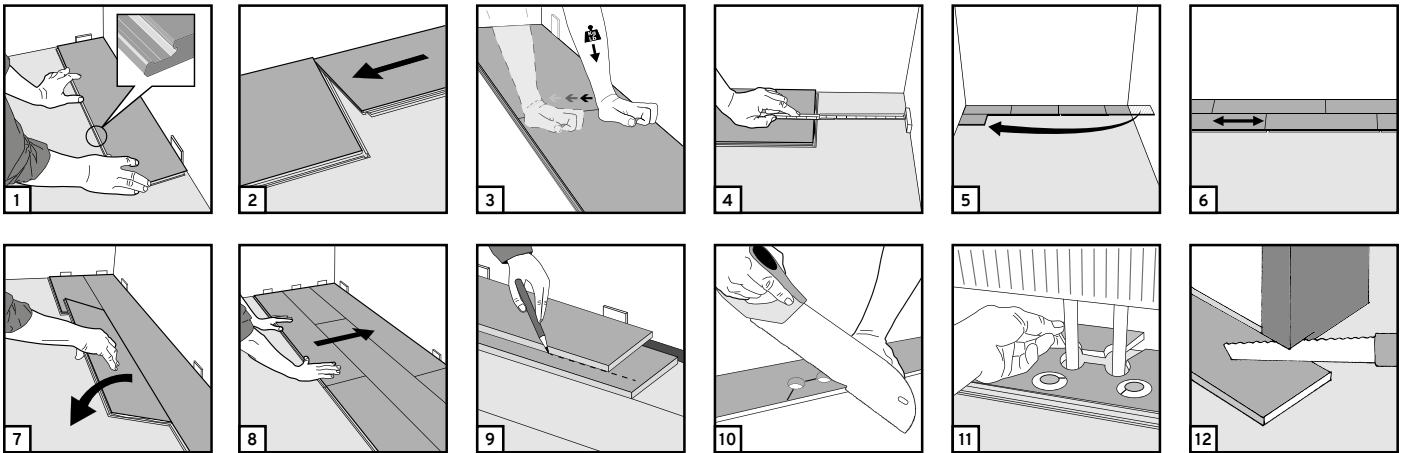

### 1. First Plank, First Row:

The planks are laid without glue. Start to lay the floor in the left-hand corner of the room with the lower male profile facing towards you (Fig 1). A minimum expansion gap of 5mm should be left around the installation perimeter and anything protruding from the subfloor. Use small offcuts from the planks as spacers between the planks and the walls to help achieve the correct size gap.

### 2. Second Plank, First Row:

Align the short end of the second plank close to the corresponding short end of the previous plank. Carefully fold it down with a single action movement (Fig 2). Press firmly down on the short end of the next plank into the corresponding short edge of the first one, (Fig 3). These should now lock securely together. It is important to ensure early in the installation that the short joints are fully engaged and locked into one another. Provided the planks align and fit flush with each other on the short joints after any hand pressure has been released, then the joints will be fully engaged. If they do not reapply pressure until this is achieved. Complete the first row in the same way (Continue in this way to as far as full planks can be installed to the end of this first row). Note – if any planks require disassembly, the short sides can only be separated when flat on the floor, secure one plank and slide the second plank towards you. The long side can be separated using the reversal of the installation procedure (Fig 13 & 14).

### 3. Last Plank, First Row:

Insert correct sized spacer between the end of the first row and the wall to ensure the correct expansion gap is set. Before cutting this last plank first turn it around through 180° so the overhanging male profile on the short edge is facing the spacer / wall. This will ensure you have the correct profile required when positioning. Measure the length of this plank to fit (Fig 4), cut to correct length.

### 4. First Plank, Second Row:

Insert a spacer between the end of the first row and the wall (expansion gap). Start this new row with the leftover piece from the last row (min length 350mm – Fig 5). Insert the upper male profile of the long side of the plank into the

corresponding lower profile of the long edge of the plank in the previous row, at a slight angle. Press down until it locks into place. Always randomly stagger all short joints by a minimum of 150mm from the nearest short joint on the previous row (Fig 6) Do not forget to include the required expansion gap to the wall.

### 5. Second Plank, Second Row:

Gently place the plank close to the short end of the previous one. At a slight angle, insert the upper male profile of the long side of the plank into the corresponding lower profile of the long edge of the plank in the previous row. Fold it down in a single action movement ensuring the corner of the long and short sides connect into the corresponding profiles of the short edge of the first plank second row. (Fig 7) Press down and firmly lock into place; (Fig 8).

### 6. Last Row:

To cut the planks to fit the last row, position them one at a time directly over the previous row in the direction you will be laying them. Lay these planks on top of the installed row (Fig 9). Hold them firmly in place. Then line up a third plank on top. Place the edge of this plank against the wall after inserting a spacer. Use the edge of this plank to mark the cutting line with a pencil on the plank beneath (minimum width 50mm). Carefully scribe along this line with the utility knife. Remember to place a spacer to the wall before measuring to ensure the correct expansion gap is left. After scribing cut the planks lengthwise. Remember to allow for the expansion gap. Carefully cut any excess with either a saw or a sharp utility knife. If needed a pull bar can be used to pull the plank of the last row into the corresponding profiles of the penultimate row.

### 7. Radiator Pipes:

Mark the centres of the holes on both the long and short sides using a carpenter's square and a pencil. Where the marks cross, drill a pilot hole using a thin #6 or #8 drill bit. Further drill the hole with a spade bit wide enough to accommodate both the diameter of the pipe and the required expansion gap. Cut around as shown with a saw or with a sharp utility knife (Fig 10). Install the floor plank. If necessary, put a bead of contact glue on the cut piece and replace. Insert a spacer directly

behind the inserted piece to wedge it in place ensuring that the correct sized expansion gap has been left. Leave this in place until the glue has hardened (Fig 11).

### 8. Door Frames / Architraves:

When installing Rigid Core Loc Vinyl Flooring around a door frame or architrave cut into the door frame / architrave with a handsaw, using an offcut plank as a guide for the height and the amount to trim off the door frame (Fig 12). Slide the cut piece under the door frame. Because Rigid Core Loc Vinyl Flooring is a floating floor, it can be walked on straight away after it has been installed. Remember to take out any offcuts or spacers you have used to gauge the expansion gap around the perimeter. Skirting / base boards, quadrants or scotia can be used to conceal the expansion gap; however, they should be fitted directly to the wall or skirting board and never directly onto the surface of the product. Leave a small gap between the two (2mm) to allow for free movement of the plank. This gap must be left 100% clear. Do not use Mastic or sealant to fill this gap.

### Dismantling Planks

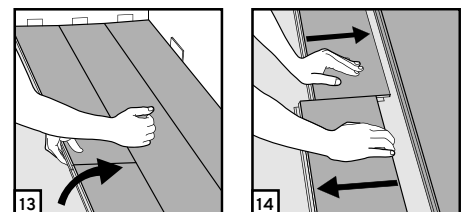

Separate the whole row by carefully lifting up and release the whole row (Fig 13).

Disassemble the tiles by sliding the short ends horizontally (Fig 14).

For more information please contact  
**Polyflor's Customer Technical Support Dept on  
+44 (0)161 767 1912.**





# Rigid Core Loc Tile Installation Instructions

## GENERAL INFORMATION

Rigid Core Loc Vinyl Flooring is constructed of PVC over a rigid core to offer a strong, durable construction which is 100% waterproof\* and offers impressive acoustic performance. The tile size is 304.8mm x 609.6mm. The tiles are locked together without the need for any glue by a unique locking system to create a floating floor where the tiles can be installed and locked together in a single action. Rigid Core Loc Vinyl Flooring incorporates an acoustic base and therefore requires no underlay. To ensure the best finished appearance it is essential to follow these installation instructions carefully.

## PRIOR TO INSTALLATION

When installing Rigid Core Loc Vinyl Flooring Tiles always follow current national standards for the installation of floor coverings. Best current installation practice incorporating the latest technical developments should also be employed. The preparation of the subfloor, the installation of the floor covering, and the measures taken to safeguard value are key factors in ensuring optimum suitability and performance of resilient floor coverings. On receipt of materials, check that the colours correspond to those ordered and that there is no damage or visual defects in the material. Check that the material is from one batch. Claims for visual defects can only be accepted prior to installation and cutting.

## PREPARATION OF SUBFLOORS

Subfloors should be prepared as described in BS 8203 / DIN 18365 or prevailing local / national standards. Rigid Core Loc Vinyl Flooring can be installed over most hard subfloors, provided they are prepared in accordance with local standards. Subfloors must be hard, clean, and free from contamination, dry, durable, flat and sound. Solid subfloors must be tested in accordance to local standards to ensure they are not damp. Carpets and soft floorings are unsuitable as a base for the installation of Rigid Core Loc Vinyl Flooring and will need to be removed prior to installation. Remove all debris and vacuum the whole subfloor area prior to commencing the installation. Where underfloor heating is used the maximum temperature on the surface of the flooring must never exceed 27°C. Subfloors should be tested for moisture in accordance with local standards. Solid subfloors should demonstrate a maximum damp content of 75%RH before the installation can begin.

Residual moisture content:

Cement	without UFH	2% CM
	with UFH	1.8% CM
Anhydrite	without UFH	0.5% CM
	with UFH	0.3% CM

Remove any unevenness in the subfloor prior to installation. Subfloor levels should be in accordance with local national standards and in any event, should never exceed a maximum deviation of 5mm when measured under a 3m long straight edge. High spots and ridges should be removed to prevent damaging the tiles' locking mechanism.

## CONDITIONING

Rigid Core Loc Vinyl Flooring must be protected against dirt and moisture during storage and both before and during the installation. The climatic conditions acceptable for the installation of Rigid Core Loc Vinyl Flooring are:

- Floor temperature > 15°C
- Room temperature > 18°C

Prior to installation, open the boxes and place them in the room they are to be installed in for a minimum of 48 hours BEFORE the installation commences, so the material can acclimatise. Boxes should never be stacked greater than 3 high.

Ensure that the room temperatures are between 18 and 27°C during the conditioning period. Shuffle the tiles to ensure a random appearance before installation.

## INSTALLATION

As Rigid Core Loc Vinyl Flooring is a floating floor, a minimum expansion gap of 5mm should be left around the entire installation perimeter and anything protruding from the subfloor such as radiator pipes, fixed down items etc. For larger installations over 5m x 5m an expansion gap of 1mm per linear meter of room length should be used\*\*. For example, a room 8m x 4m would require an expansion gap of 8mm around the entire perimeter of the room and around anything protruding from the floor. In areas under 5m x 5m use small offcuts as spacers between the tiles and the walls to help achieve the correct expansion gap size. Skirting boards should be removed and door frames / architraves undercut to allow for possible expansion. A suitable quadrant or scotia trim can be used to cover the expansion gap.

Rigid Core Loc Vinyl Flooring is a loose lay product. In areas subject to large temperature fluctuations such as heavily glazed areas and areas subject to direct sunlight, special care must be taken including a larger expansion gap of a minimum 10mm and adequate UV protection.

If installing in multiple rooms, finish the Rigid Core Loc Vinyl Flooring Tiles in the doorway on either side of the door to make separate floors. Allow a larger expansion gap between two such floors of double that left around the perimeter. Use two small offcut pieces of Rigid Core Loc Vinyl Flooring placed back-to-back to gauge the correct expansion gap size at door thresholds. A suitable threshold strip can then be installed to cover the resultant gap. Rigid Core Loc Vinyl Flooring should never be installed across multiple rooms as one floor. Tiles should always be laid with offset joints in a symmetrical brick bond pattern. When adjoining other floor coverings, finish the Rigid Core Loc Vinyl Flooring in the doorway. An appropriate expansion gap should be left between the Rigid Core Loc Vinyl Flooring and the adjoining floor covering. This can be covered using a suitable threshold or diminishing strip (see diagram below). Areas over 10m x 10m will require specialist advice. Please contact Polyflor's Customer Technical Support Dept on +44 (0)161 767 1912.

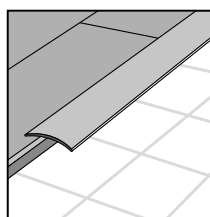

## YOU WILL NEED

- Pencil
- Utility knife
- Retractable measuring tape or folding ruler
- Handsaw / Hacksaw
- Carpenter's 90° square
- Pull bar

The use of safety glasses and protective gloves should also be considered.

\* Rigid Core Loc Vinyl Flooring Tiles are 100% waterproof. Therefore, they will not absorb water and the structural integrity of the product will not be affected by water e.g. no swelling. In the case of standing water or flooding, Rigid Core Loc Vinyl Flooring will not act as a barrier between standing water/flooding and the subfloor, and as such is not recommended for continually wet areas such as walk-in shower rooms.

\*\* Room Length follows the direction the longest side of the tile is installed.



# Rigid Core Loc Tile Installation Instructions

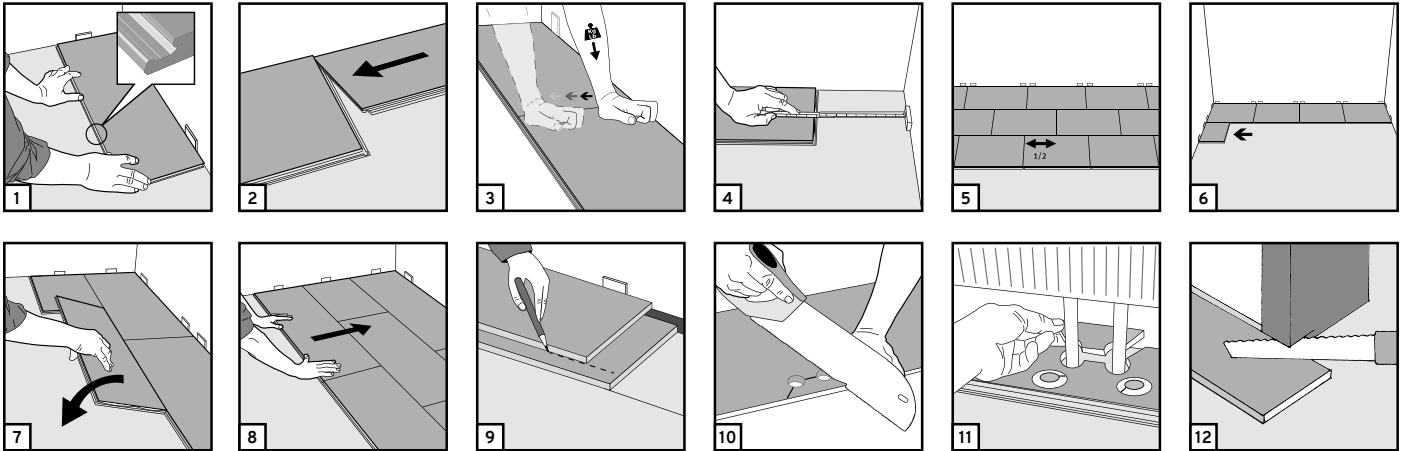

### 1. First Tile, First Row:

The tiles are laid without glue. Start to lay the floor in the left-hand corner of the room with the lower male profile facing towards you (Fig 1). A minimum expansion gap of 5mm should be left around the installation perimeter and anything protruding from the subfloor. Use small offcuts from the tiles as spacers between the tiles and the walls to help achieve the correct size gap.

### 2. Second Tile, First Row:

Align the short end of the second tile close to the corresponding short end of the previous tile. Carefully fold it down with a single action movement (Fig 2). Press firmly down on the short end of the next tile into the corresponding short edge of the first one, (Fig 3). These should now lock securely together. It is important to ensure early in the installation that the short joints are fully engaged and locked into one another. Provided the tiles align and fit flush with each other on the short joints after any hand pressure has been released, then the joints will be fully engaged. If they do not reapply pressure until this is achieved. Complete the first row in the same way (Continue in this way to as far as full tiles can be installed to the end of this first row). Note - if any tiles require disassembly, the short sides can only be separated when flat on the floor, secure one tile and slide the second tile towards you. The long side can be separated using the reversal of the installation procedure (Fig 13 & 14).

### 3. Last Tile, First Row:

Insert correct sized spacer between the end of the first row and the wall to ensure the correct expansion gap is set. Before cutting this last tile first turn it around through 180° so the overhanging male profile on the short edge is facing the spacer / wall. This will ensure you have the correct profile required when positioning. Measure the length of this tile to fit (Fig 4), cut to correct length.

### 4. First Tile, Second Row:

Tiles should be installed in a symmetrical brick pattern (Fig 5), cut down the first tile to maintain the symmetrical brick pattern (Fig 6) keeping the same size distance spacing against the previous row. Do not forget to insert a spacer to provide the required expansion gap to the wall. At a slight

angle, insert the upper male profile of the long side of the tile into the corresponding lower profile of the long edge of the tile in the previous row, press down until it locks into place.

### 5. Second Tile, Second Row:

Gently place the tile close to the short end of the previous one. At a slight angle, insert the upper male profile of the long side of the tile into the corresponding lower profile of the long edge of the tile in the previous row. Fold it down in a single action movement ensuring the corner of the long and short sides connect into the corresponding profiles of the short edge of the first tile second row. (Fig 7) Press down and firmly to lock into place; (Fig 8).

### 6. Last Row:

To cut the tiles to fit the last row, position them one at a time directly over the previous row in the direction you will be laying them. Lay these tiles on top of the installed row (Fig 9). Hold them firmly in place. Then line up a third tile on top. Place the edge of this tile against the wall after inserting a spacer. Use the edge of this tile to mark the cutting line with a pencil on the tile beneath (minimum width 50mm). Carefully scribe along this line with the utility knife. Remember to place a spacer to the wall before measuring to ensure the correct expansion gap is left. After scribing cut the tiles lengthwise. Remember to allow for the expansion gap. Carefully cut any excess with either a saw or a sharp utility knife. If needed a pull bar can be used to pull the tile of the last row into the corresponding profiles of the penultimate row.

### 7. Radiator Pipes:

Mark the centres of the holes on both the long and short sides using a carpenter's square and a pencil. Where the marks cross, drill a pilot hole using a thin #6 or #8 drill bit. Further drill the hole with a spade bit wide enough to accommodate both the diameter of the pipe and the required expansion gap. Cut around as shown with a saw or with a sharp utility knife (Fig 10). Install the floor tile. If necessary, put a bead of contact glue on the cut piece and replace. Insert a spacer directly behind the inserted piece to wedge it in place ensuring that the correct sized expansion gap has been left. Leave this in place until the glue has

hardened (Fig 11).

### 8. Door Frames / Architraves:

When installing Rigid Core Loc Vinyl Flooring around a door frame or architrave cut into the door frame / architrave with a handsaw, using an offcut tile as a guide for the height and the amount to trim off the door frame (Fig 12). Slide the cut piece under the door frame. Because Rigid Core Loc Vinyl Flooring is a floating floor, it can be walked on straight away after it has been installed. Remember to take out any offcuts or spacers you have used to gauge the expansion gap around the perimeter. Skirting boards, base boards, quadrants or scotia can be used to conceal the expansion gap; however, they should be fitted directly to the wall or skirting board and never directly onto the surface of the product. Leave a small gap between the two (2mm) to allow for free movement of the tile. This gap must be left 100% clear. Do not use Mastic or sealant to fill this gap.

### Dismantling Tiles

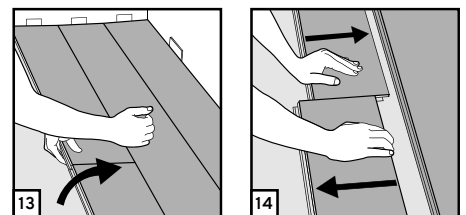

Separate the whole row by carefully lifting up and release the whole row (Fig 13).

Disassemble the tiles by sliding the short ends horizontally (Fig 14).

For more information please contact Polyflor's Customer Technical Support Dept on +44 (0)161 767 1912.